

Article number: 20166V502SW

Description: Off-set baseplate clamps GN166-V50-2-SW
GN166

Measures

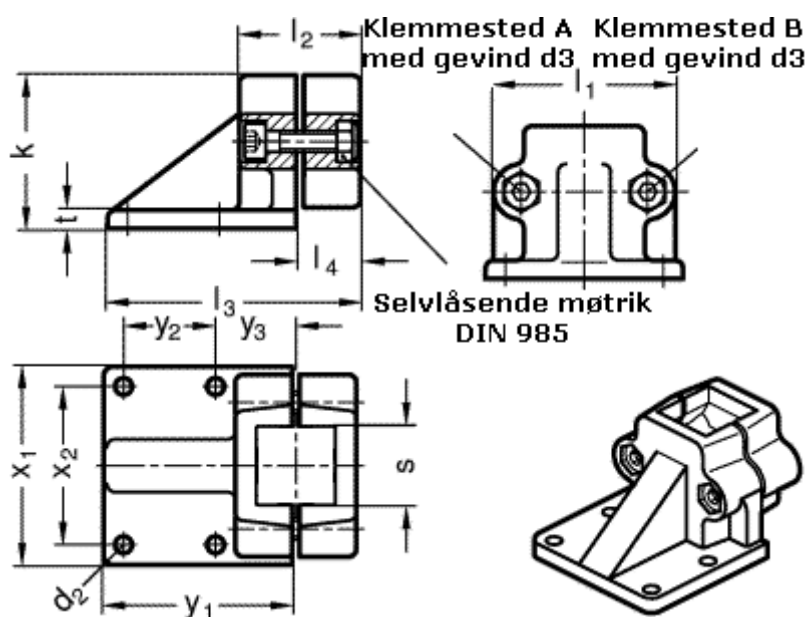

d2 = 11	t = 14
d3 = M10	x1 = 115
k = 91	x2 = 90
l1 = 98	y1 = 108
l2 = 70	y2 = 50
l3 = 145	y3 = 45
l4 = 35	
S = V50	